

SPIRO® SYSTEM 02

TEE E CROCI CON STACCO A 90° "TCPL" - "XCPL"

TCPL-XCPL

Tee e croci a 90°



Descrizione

TCPL/XCPL = stampati con PSL
 XCPL: $\varnothing d_4$ può variare rispetto a $\varnothing d_3$

Esempio di ordinazione

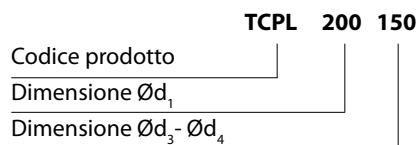

Dimensioni

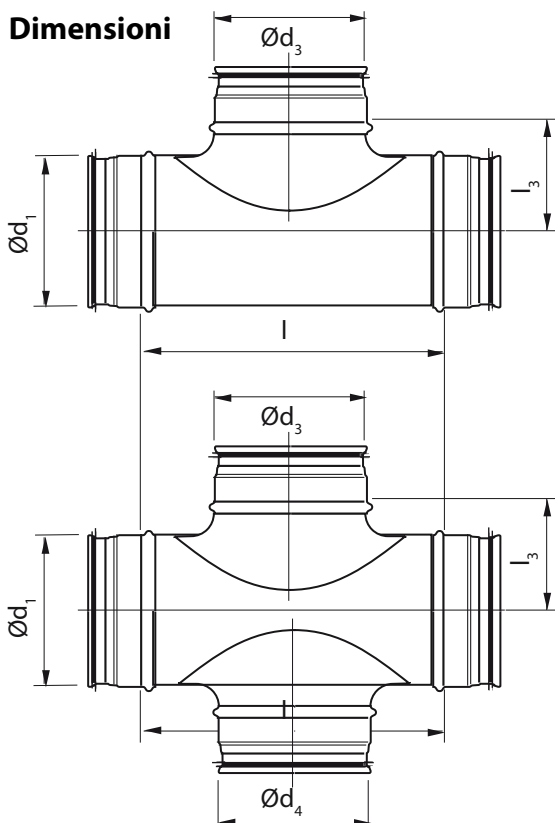

$\varnothing d_1$ nom	$\varnothing d_3 \varnothing d_4$ nom	l mm	l_3 mm	kg
80	80	140	52	0,36
100	80	103	65	0,23
100	100	130	65	0,32
125	80	97	75	0,34
125	100	130	78	0,37
125	125	165	83	0,44
140	80	140	82	0,56
140	100	175	85	0,65
140	125	215	70	0,76
140	140	230	90	0,78
150	80	140	87	0,58
150	100	175	90	0,69
150	125	215	95	0,76
150	140	230	95	0,82
150	150	260	95	0,94
160	80	140	92	0,59
160	100	130	95	0,46
160	125	166	100	0,53
160	140	230	100	0,87
160	150	260	100	0,99
160	160	209	105	0,63
180	80	140	102	0,92
180	100	175	105	0,80
180	125	215	110	0,91

10
09
08
07
06
05
04
03
02
01
AB

02 SPIRO® SYSTEM

TCPL-XCPL

Ød ₁ nom	Ød ₃ Ød ₄ nom	l mm	l ₃ mm	kg
180	140	230	110	0,96
180	150	260	110	1,08
180	160	260	115	1,06
180	180	285	115	1,44
200	80	140	112	0,77
200	100	175	115	0,88
200	125	215	115	1,02
200	140	230	120	1,07
200	150	260	120	1,19
200	160	209	125	0,67
200	180	285	125	1,35
200	200	249	125	1,21
224	80	140	124	0,85
224	100	175	127	1,01
224	125	215	132	1,14
224	140	230	132	1,20
224	150	260	132	1,29
224	160	260	137	1,28
224	180	285	137	1,46
224	200	346	137	1,69
250	80	156	137	1,13
250	100	175	140	1,22
250	125	220	145	1,48
250	140	230	145	1,48
250	150	255	145	1,55
250	160	256	150	1,58
250	180	306	150	1,79
250	200	306	150	1,78
250	224	350	150	2,09
250	250	296	150	1,65
280	80	156	155	1,25
280	100	175	155	1,37
280	125	220	160	1,56
280	140	230	160	1,63
280	150	255	160	1,72
280	160	256	165	1,75
280	180	306	165	1,97
280	200	306	165	2,01
280	224	350	165	2,27
280	250	350	140	2,44
280	280	390	140	2,67
300	80	156	162	1,36
300	100	175	165	1,47
300	125	220	170	1,68
300	140	230	170	1,74
300	150	255	170	1,86
300	160	256	175	1,87
300	180	306	175	2,12
300	200	306	175	2,15
300	224	350	175	2,41
300	250	350	175	2,50

Ød ₁ nom	Ød ₃ Ød ₄ nom	l mm	l ₃ mm	kg
300	280	390	150	2,53
300	300	430	175	3,55
315	80	156	170	1,43
315	100	175	173	1,50
315	125	220	178	1,76
315	140	230	178	1,82
315	150	355	178	2,38
315	160	256	182	1,96
315	180	306	182	2,21
315	200	306	182	2,14
315	224	350	182	2,51
315	250	350	182	2,59
315	280	390	182	3,00
315	300	430	182	3,21
315	315	363	182	2,20
355	100	175	193	1,73
355	125	220	198	1,96
355	140	230	198	2,03
355	150	255	198	2,46
355	160	256	203	2,45
355	180	306	203	2,81
355	200	306	203	2,82
355	224	350	203	3,13
355	250	350	203	3,18
355	280	390	178	3,63
355	300	430	203	3,87
355	315	455	203	4,06
355	355	470	203	5,14
400	100	175	215	2,27
400	125	225	220	2,81
400	160	266	225	3,02
400	200	300	225	3,37
400	224	350	225	3,74
400	250	350	225	3,79
400	280	390	200	4,23
400	300	430	225	4,47
400	315	415	225	4,42
400	355	470	225	5,04
400	400	510	225	6,20
450	100	175	240	2,76
450	125	225	245	3,15
450	160	266	250	3,38
450	200	300	250	3,75
450	224	350	250	4,16
450	250	350	250	4,23
450	280	390	225	4,64
450	300	430	250	4,89
450	315	415	250	4,82
450	355	470	250	5,16
450	400	510	250	5,81
450	450	550	225	6,99

TCPL-XCPL

SPIRO[®] SYSTEM 02

Ød ₁ nom	Ød ₃ Ød ₄ nom	l mm	l ₃ mm	kg
500	100	175	265	3,06
500	125	225	270	3,35
500	160	266	275	3,77
500	200	300	275	4,14
500	250	350	275	4,68
500	300	430	275	5,36
500	315	415	275	5,30
500	355	470	275	5,70
500	400	510	275	6,34
500	450	550	250	6,56
500	500	552	290	8,27
560	100	175	295	3,59
560	125	225	300	3,92
560	160	266	305	4,41
560	200	300	305	4,78
560	250	350	305	5,38
560	300	430	280	5,86
560	315	415	305	6,06
560	355	470	305	6,57
560	400	510	305	7,08
560	450	550	280	7,38
560	500	552	280	7,57
560	560	610	280	9,69
600	100	175	315	3,83
600	125	225	320	4,19
600	160	266	325	4,73
600	200	300	325	5,10
600	250	350	325	5,73
600	300	430	300	6,36
600	315	415	325	6,46
600	355	470	300	6,98
600	400	510	325	7,43
600	450	550	300	7,84
600	500	552	300	7,91
600	560	610	300	8,76
600	600	650	300	10,8
630	100	175	330	4,03
630	125	225	335	4,41
630	160	266	340	4,99
630	200	300	340	5,35
630	250	350	340	6,00
630	300	450	315	7,23
630	315	415	340	6,77
630	355	470	315	7,18
630	400	510	340	7,69
630	450	555	315	8,24
630	500	552	340	8,44
630	560	610	315	9,11
630	600	650	315	9,58
630	630	680	340	11,3

10
09
08
07
06
05
04
03
02
01
AB

02 SPIRO® SYSTEM

TCPL-XCPL

Dati tecnici

Aria in ingresso

Flusso divergente

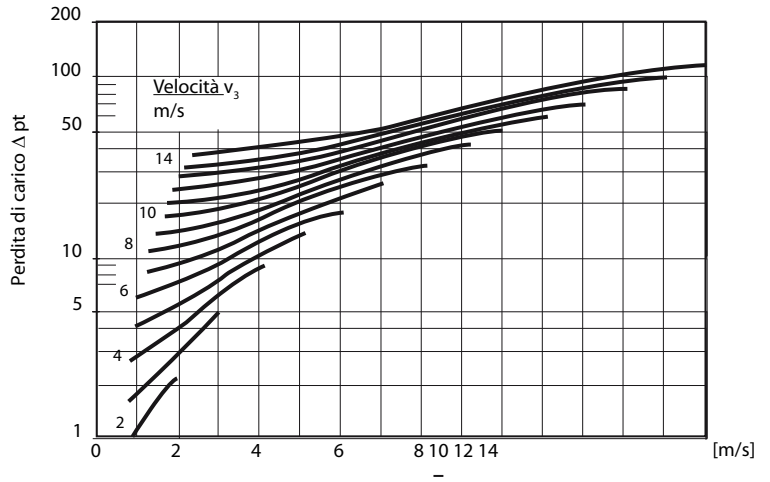
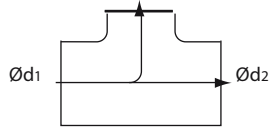

Flusso divergente

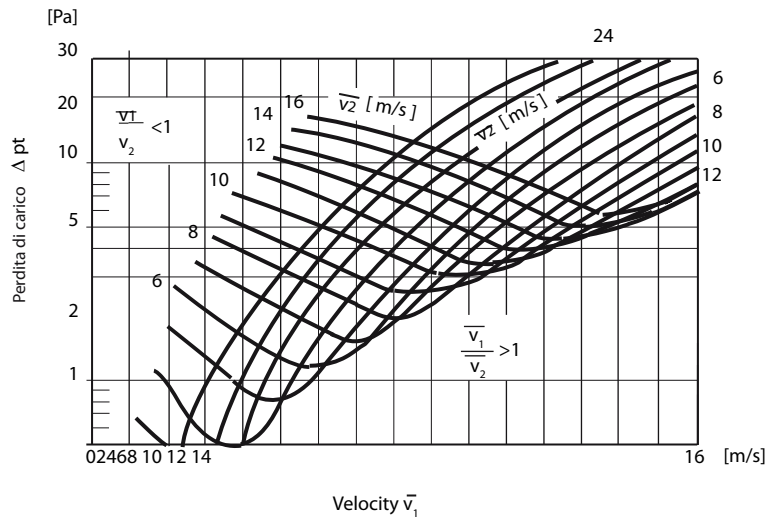
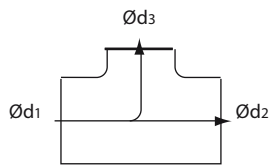

Flusso divergente

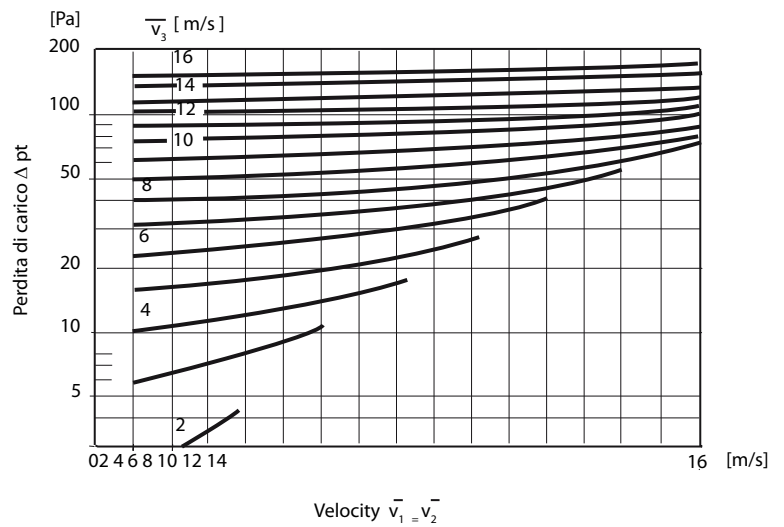
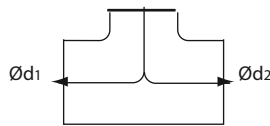

10
09
08
07
06
05
04
03
02
01
AB

TCPL-XCPL

Dati tecnici

Aria in uscita

Flusso convergente

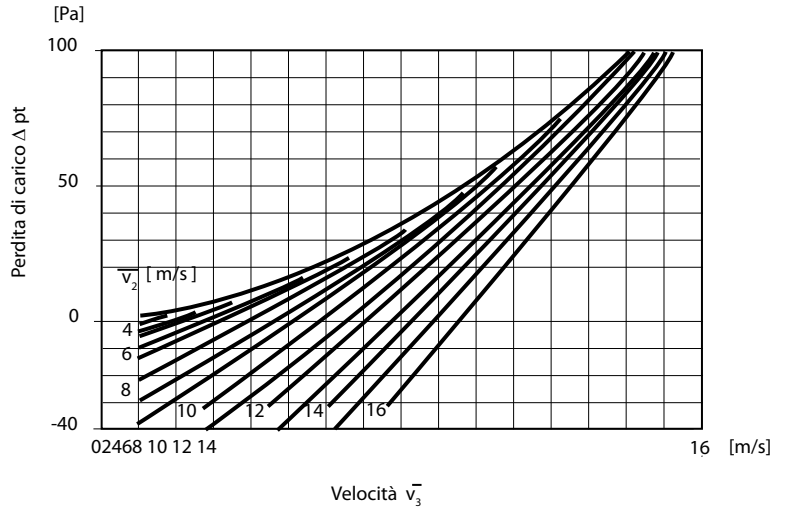
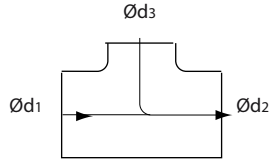

Flusso convergente

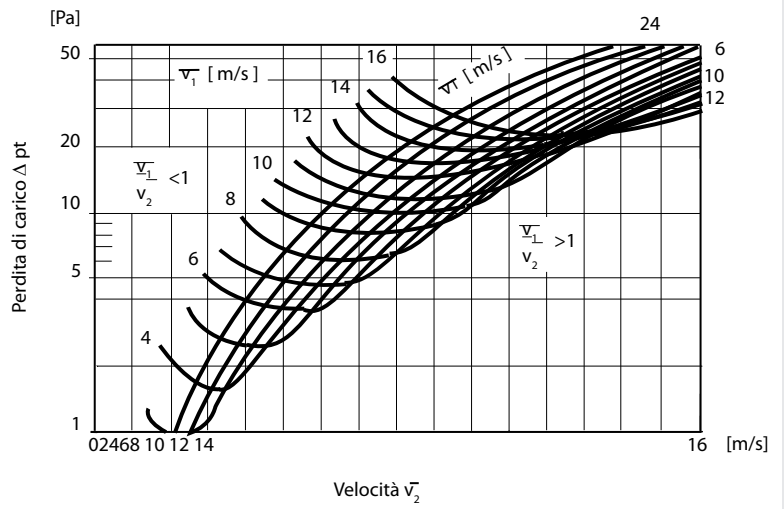
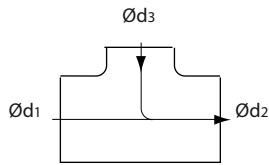

Flusso convergente

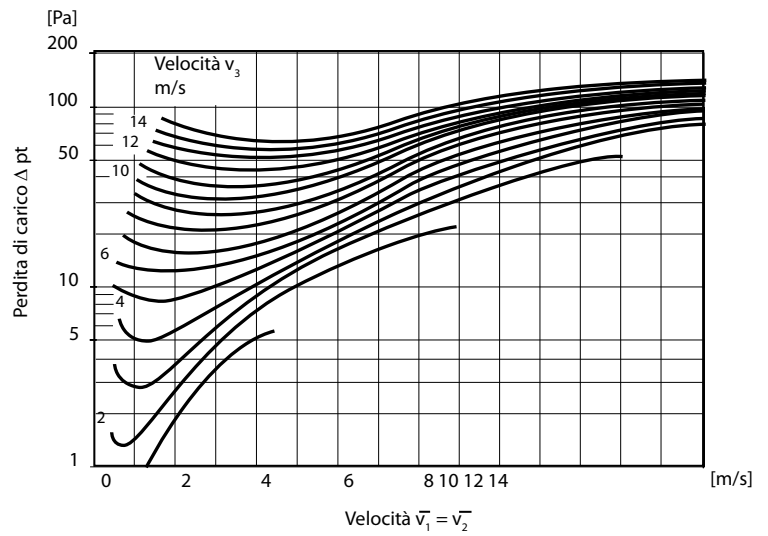
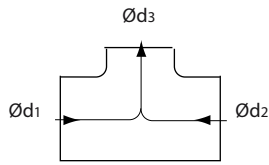

10
09
08
07
06
05
04
03
02
01
AB